

85mm CONCRETE + 220mm PODS

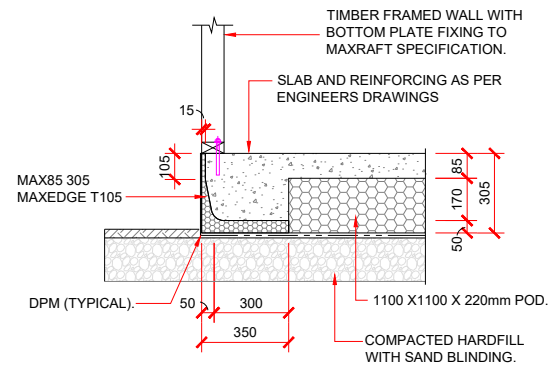

EXTERNAL FOOTING DETAIL
MAXEDGE T105 - 90mm FRAMING

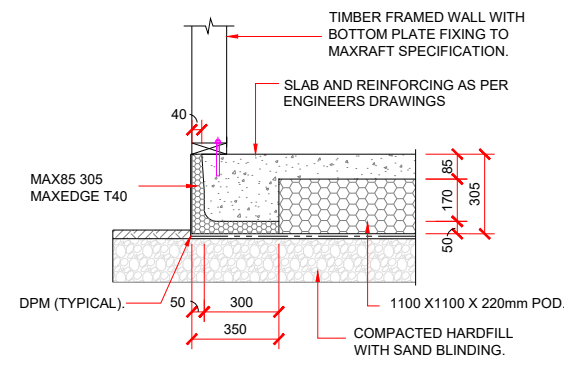

EXTERNAL FOOTING DETAIL
MAXEDGE T40 - 140mm FRAMING

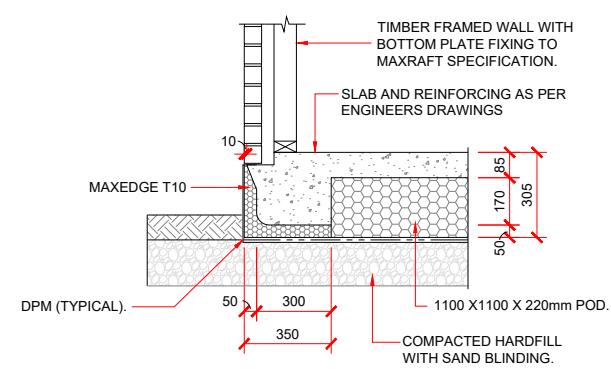

BRICK / STONE VENEER
REBATE DETAIL

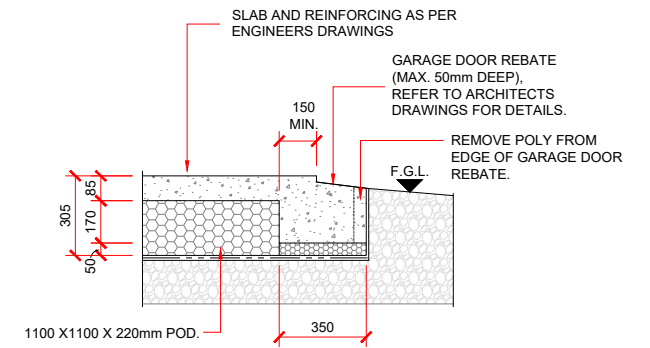

GARAGE DOOR REBATE DETAIL

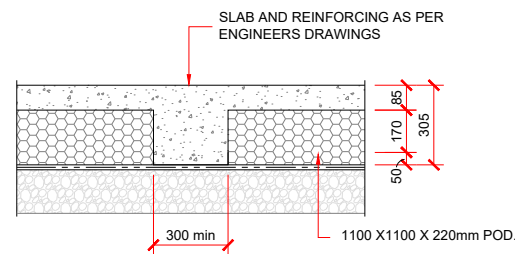

INTERNAL FOOTING DETAIL

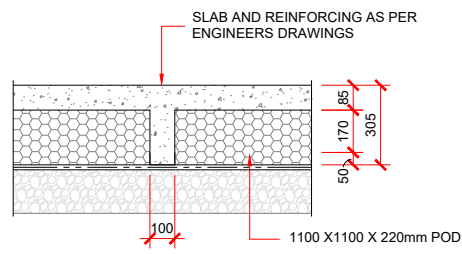

INTERNAL RIB DETAIL

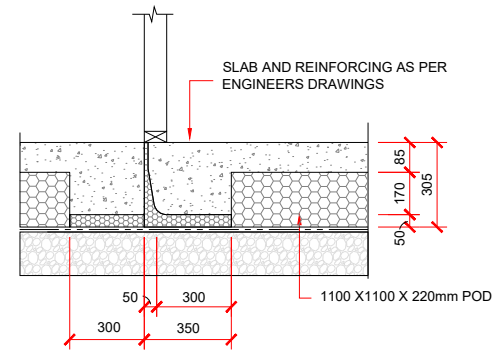

THERMAL BREAK

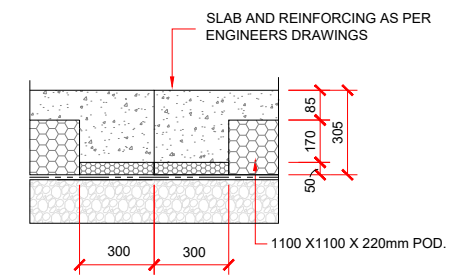

FREE JOINT / CONTROL JOINT DETAIL

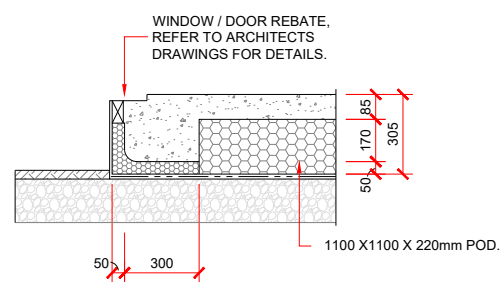

JOINERY REBATE DETAIL

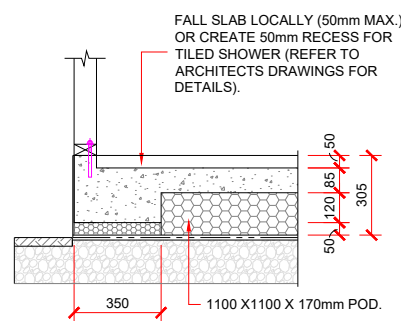

SHOWER RECESS DETAIL - 90mm FRAMING.

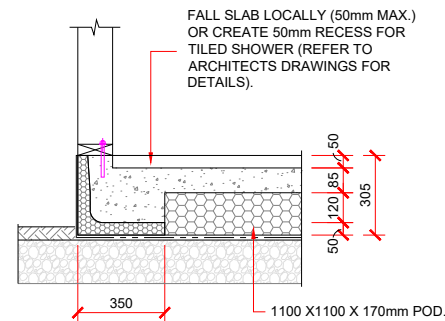

SHOWER RECESS DETAIL - 140mm FRAMING.

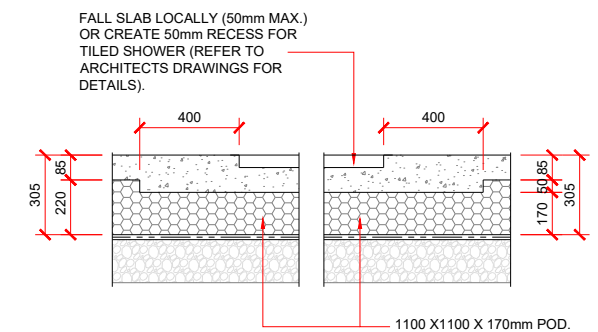

SHOWER RECESS DETAIL.

MAX85 305mm

DATE : 19/1/2024