

100mm CONCRETE + 200mm POLY

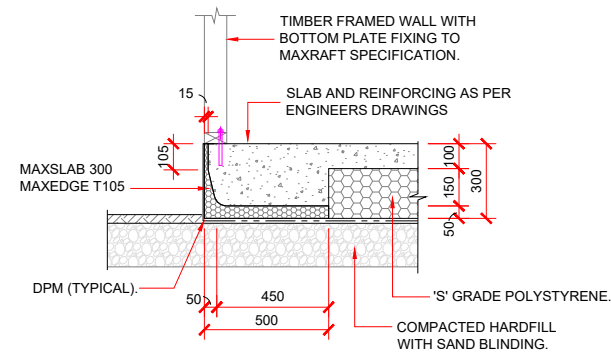

EXTERNAL FOOTING DETAIL
MAXEDGE T105 - 90mm FRAMING

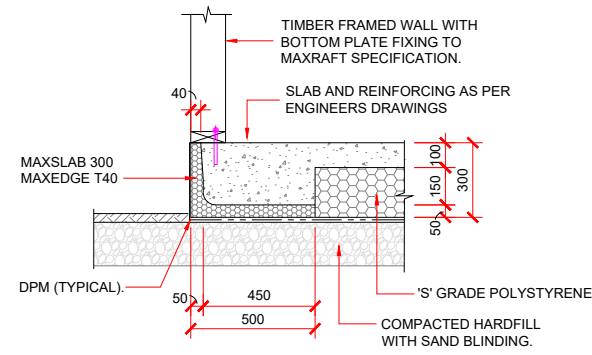

EXTERNAL FOOTING DETAIL
MAXEDGE T40 - 140mm FRAMING

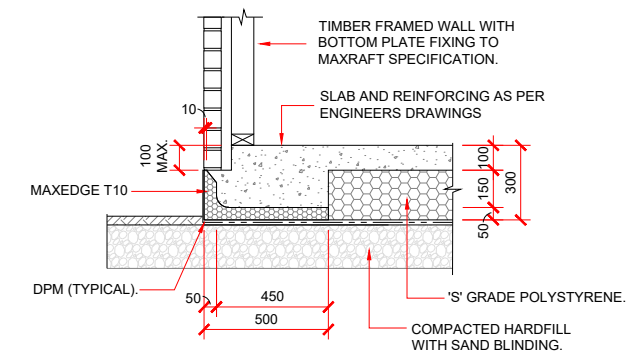

BRICK / STONE VENEER
REBATE DETAIL

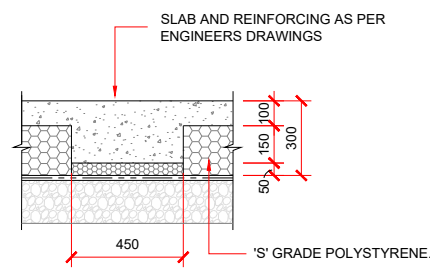

INTERNAL FOOTING DETAIL

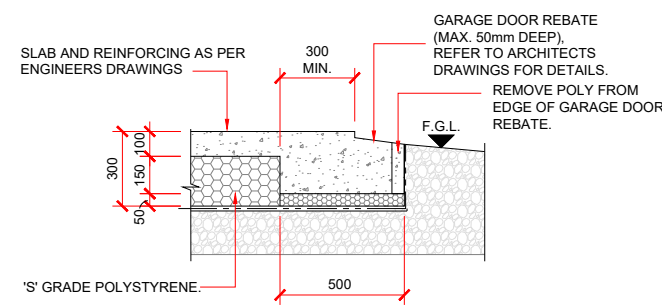

GARAGE DOOR REBATE DETAIL

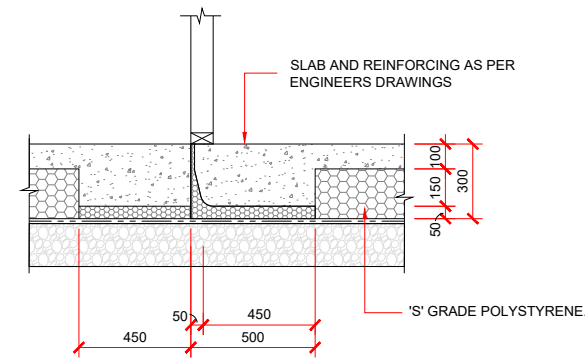

THERMAL BREAK

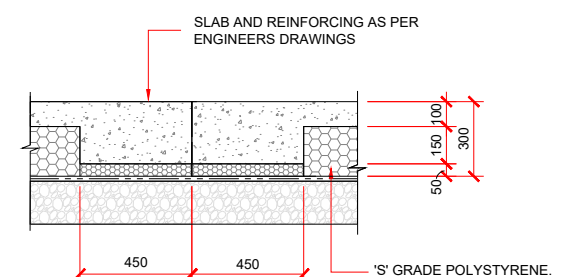

FREE JOINT / CONTROL JOINT DETAIL

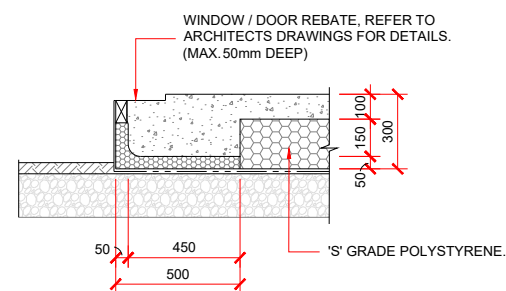

JOINERY REBATE DETAIL

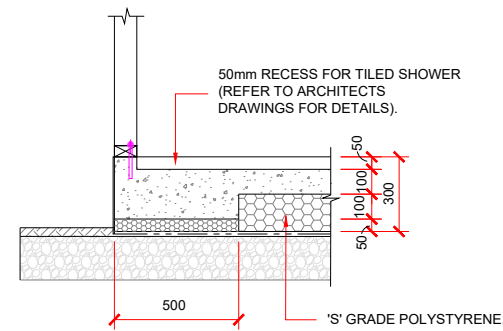

SHOWER RECESS DETAIL - 90mm FRAMING.

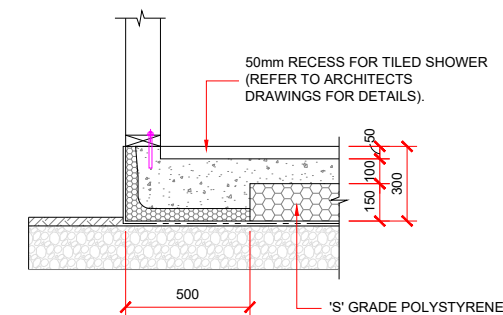

SHOWER RECESS DETAIL - 140mm FRAMING.

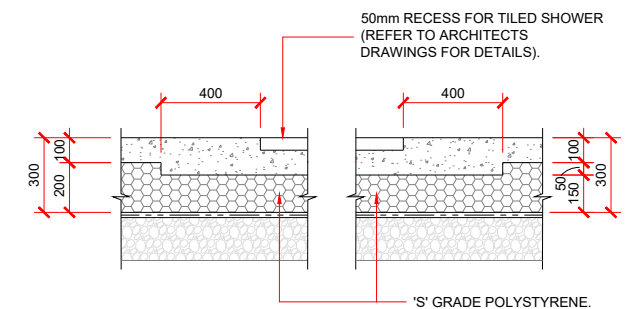

SHOWER RECESS DETAIL.

MAXSLAB STD 300

DATE : 28/11/2023