

MAXSPAN.

STRUCTURAL DRAWING LIST 9092

DWG No.	TITLE	
S.01	TABLES	0
S.02	FLOOR LAYOUT AND CROSS SECTIONS	0
S.03	FLOOR LAYOUT AND CROSS SECTIONS	0
S.04	FLOOR LAYOUT AND CROSS SECTIONS	0
S.05	FLOOR LAYOUT AND CROSS SECTIONS	0
ISSUED TO:		
henry@maxraft.co.nz		0
	DATE	19-04-2018

TABLE 1 MAXSPAN FLOOR SYSTEM DESIGNED TO IMPOSED FLOOR ACTION OF A SELF-CONTAINED DWELLING WITH 1.5kPa OR 1.8kN LOAD AS PER AS/NZS 1170.1

RIB DEPTH (mm)	250	300	350	400	450
RIB WIDTH (mm)	120	120	120	120	120
POLYSTYRENE FORMWORK DEPTH (mm)	150	200	250	300	350
RIB REINFORCEMENT					
TOP BAR	HD12	HD12	HD12	HD12	HD12
BOTTOM BAR	HD20	HD20	HD25	HD25	HD25
LINK	R6	R6	R6	R6	R6
LINK SPACING (mm)	125	125	150	175	200
RIB SPACING (m)	RIB SPAN (m)	RIB SPAN (m)	RIB SPAN (m)	RIB SPAN (m)	RIB SPAN (m)
900	3.8	4.5	5.3	5.9	6.5
1000	3.7	4.3	5.1	5.7	6.3
1100	3.6	4.2	5.0	5.6	6.1
1200	3.4	4.0	4.8	5.4	5.9
1300	3.3	3.9	4.7	5.3	5.8
1400	3.3	3.8	4.6	5.1	5.7

TABLE 2 MAXSPAN FLOOR SYSTEM DESIGNED TO IMPOSED FLOOR ACTION OF A SELF-CONTAINED DWELLING WITH 2.0kPa OR 2.7kN LOAD AS PER AS/NZS 1170.1

RIB DEPTH (mm)	250	300	350	400	450
RIB WIDTH (mm)	120	120	120	120	120
POLYSTYRENE FORMWORK DEPTH (mm)	150	200	250	300	350
RIB REINFORCEMENT					
TOP BAR	HD12	HD12	HD12	HD12	HD12
BOTTOM BAR	HD20	HD20	HD25	HD25	HD25
LINK	R6	R6	R6	R6	R6
LINK SPACING (mm)	125	125	150	175	200
RIB SPACING (m)	RIB SPAN (m)	RIB SPAN (m)	RIB SPAN (m)	RIB SPAN (m)	RIB SPAN (m)
900	3.7	4.3	5.2	5.8	6.4
1000	3.6	4.2	5.0	5.6	6.2
1100	3.5	4.1	4.9	5.4	6.0
1200	3.4	3.9	4.7	5.3	5.8
1300	3.3	3.8	4.6	5.2	5.7
1400	3.2	3.7	4.5	5.0	5.5

TABLE 3 MAXSPAN FLOOR SYSTEM DESIGNED TO IMPOSED FLOOR ACTION OF A LIGHT-VEHICLE TRAFFIC AREA WITH 2.5kPa OR 13kN LOAD AS PER AS/NZS 1170.1

RIB DEPTH (mm)	275	325	375	425	475
RIB WIDTH (mm)	120	120	120	120	120
POLYSTYRENE FORMWORK DEPTH (mm)	150	200	250	300	350
RIB REINFORCEMENT					
TOP BAR	HD12	HD12	HD12	HD12	HD12
BOTTOM BAR	HD20	HD20	HD25	HD25	HD25
LINK	R6	R6	R6	R6	R6
LINK SPACING (mm)	125	125	150	175	200
RIB SPACING (m)	RIB SPAN (m)	RIB SPAN (m)	RIB SPAN (m)	RIB SPAN (m)	RIB SPAN (m)
600	3.5	4.2	5.2	5.9	6.5
700	3.4	4.1	5.1	5.7	6.3
800	3.3	4.0	4.9	5.6	6.2
900	3.2	3.9	4.8	5.4	6.0

GENERAL NOTES:

1. REINFORCED SLAB AND RIB TO BE FORMED IN A SINGLE POUR USING A CONCRETE MIX WITH A 28 DAY STRENGTH OF 30MPa.
2. SERVICE LIMIT STATE SHORT-TERM DEFLECTION IS LIMITED TO SPAN/500 AND TOTAL LONG TERM DEFLECTION IS LIMITED TO SPAN/300.
3. DESIGN OF REINFORCED CONCRETE OF MASONRY WALL SUPPORTING THE MAXSPAN FLOOR SYSTEM IS BY OTHERS.
4. DESIGN OF PROPS, SCAFFOLDS, SHUTTERS, FORMWORKS, ETC. DURING CONSTRUCTION IS BY OTHERS.

CONSTRUCTION ISSUE

THIS DRAWING IS TO BE READ IN CONJUNCTION WITH ARCHITECT'S DRAWINGS

	CLIENT MAXRAFT	PROJECT TITLE MAXSPAN.	DRAWING TITLE TABLES.	REV.	BY.	DATE:	COMMENT:	DESIGN.	JOB No.	DRAWING No.	REV.
				0	V.M.	19-04-2018	ISSUED FOR CONSTRUCTION	P.A.	9092	S.01	0
								DRAWN.	SCALE @ A3		
								V.M.	1:20		

NOTES:

- DETAILS SHOWN ON THIS PAGE REFER TO THE MAXSPAN SUSPENDED FLOOR SYSTEM DESIGNED TO IMPOSED FLOOR ACTION OF A SELF-CONTAINED DWELLING (REFER TO TABLES 1 & 2) SUPPORTED ON A REINFORCED MASONRY WALL (BY OTHERS).

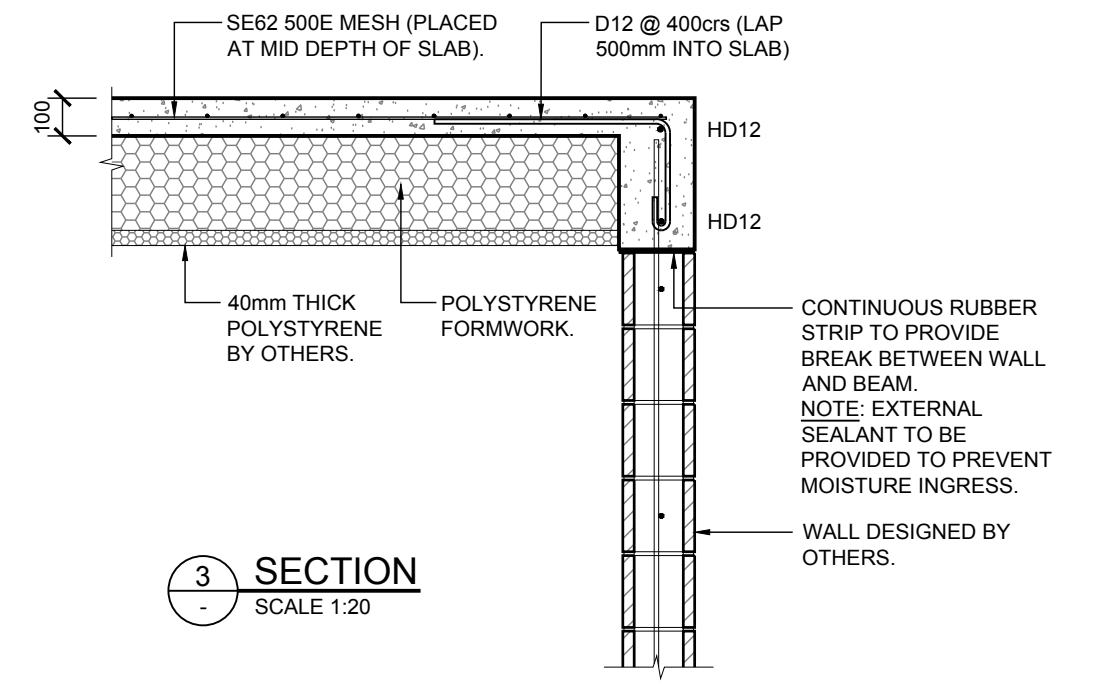
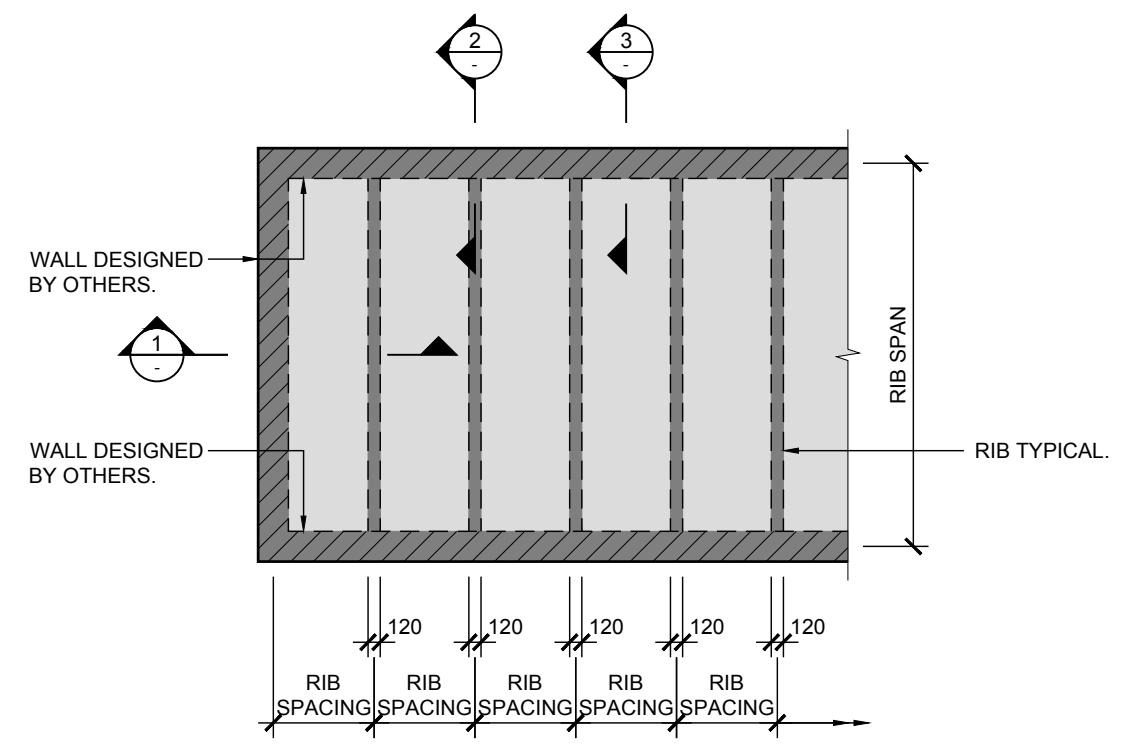
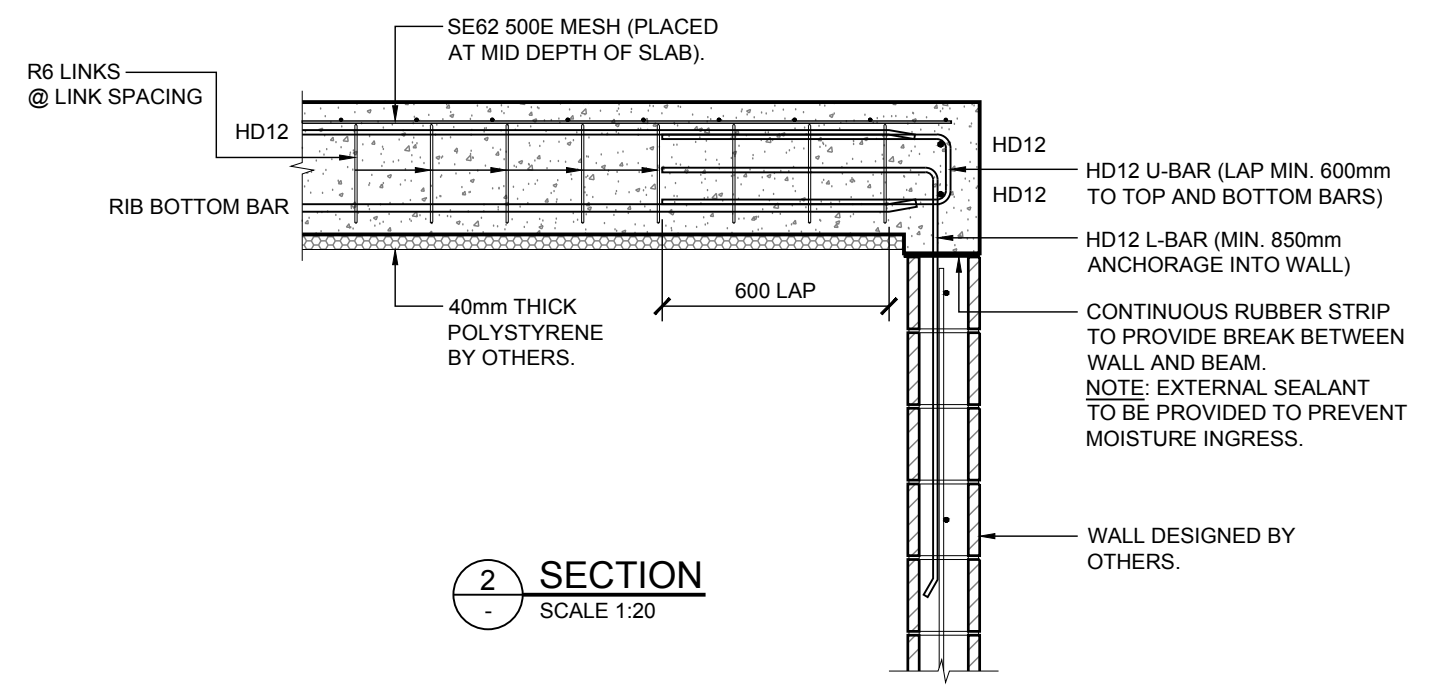
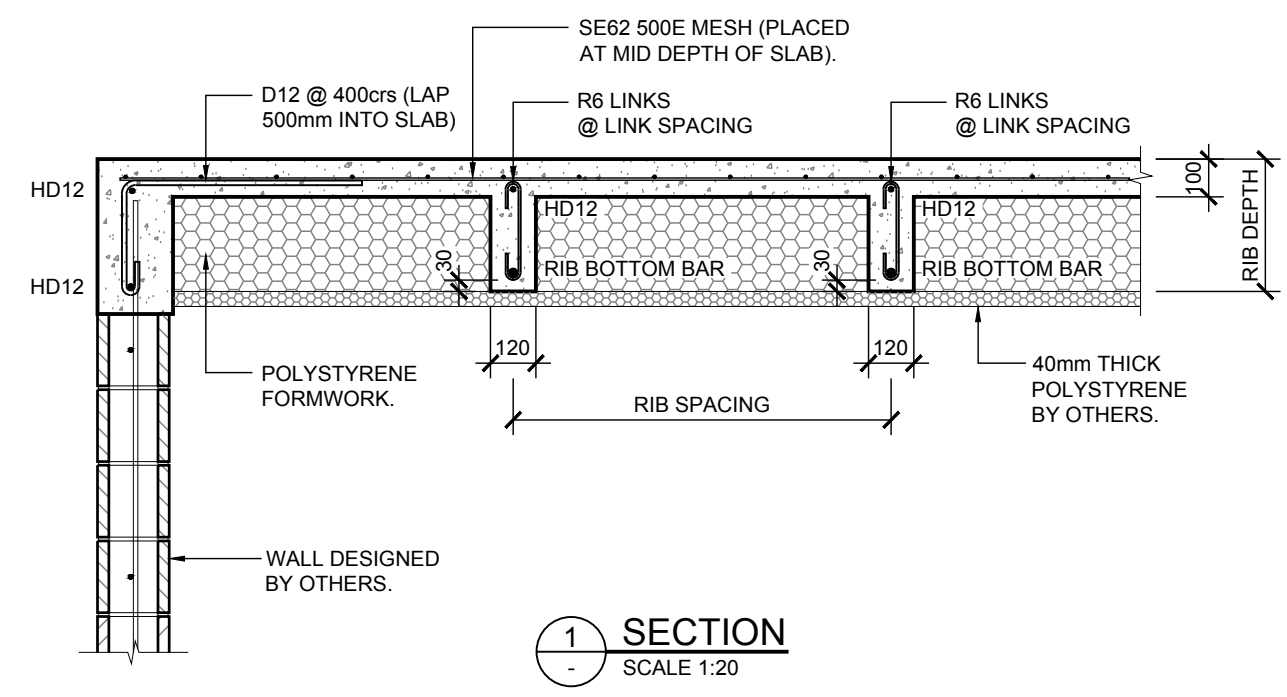

FLOOR LAYOUT
SCALE 1:75

CONSTRUCTION ISSUE

THIS DRAWING IS TO BE READ IN CONJUNCTION WITH ARCHITECT'S DRAWINGS



CLIENT
MAXRAFT

PROJECT TITLE
MAXSPAN.

DRAWING TITLE
FLOOR LAYOUT AND CROSS SECTIONS.

REV.	BY.	DATE:	COMMENT:
0	V.M.	19-04-2018	ISSUED FOR CONSTRUCTION

DESIGN.
P.A.

JOB No.
9092

DRAWN.
V.M.

SCALE @ A3
1:20

DRAWING No.
S.02

REV.
0

NOTES:

- DETAILS SHOWN ON THIS PAGE REFER TO THE MAXSPAN SUSPENDED FLOOR SYSTEM DESIGNED TO IMPOSED FLOOR ACTION OF A LITE-VEHICLE TRAFFIC AREA (REFER TO **TABLE 3**) SUPPORTED ON A REINFORCED MASONRY WALL (BY OTHERS).

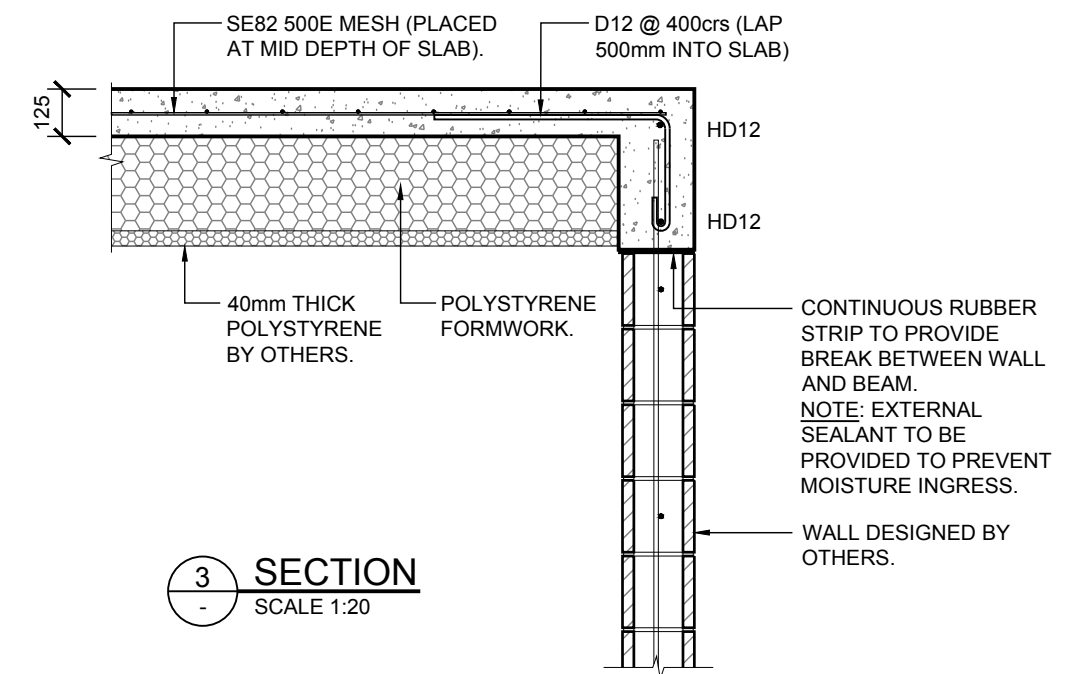
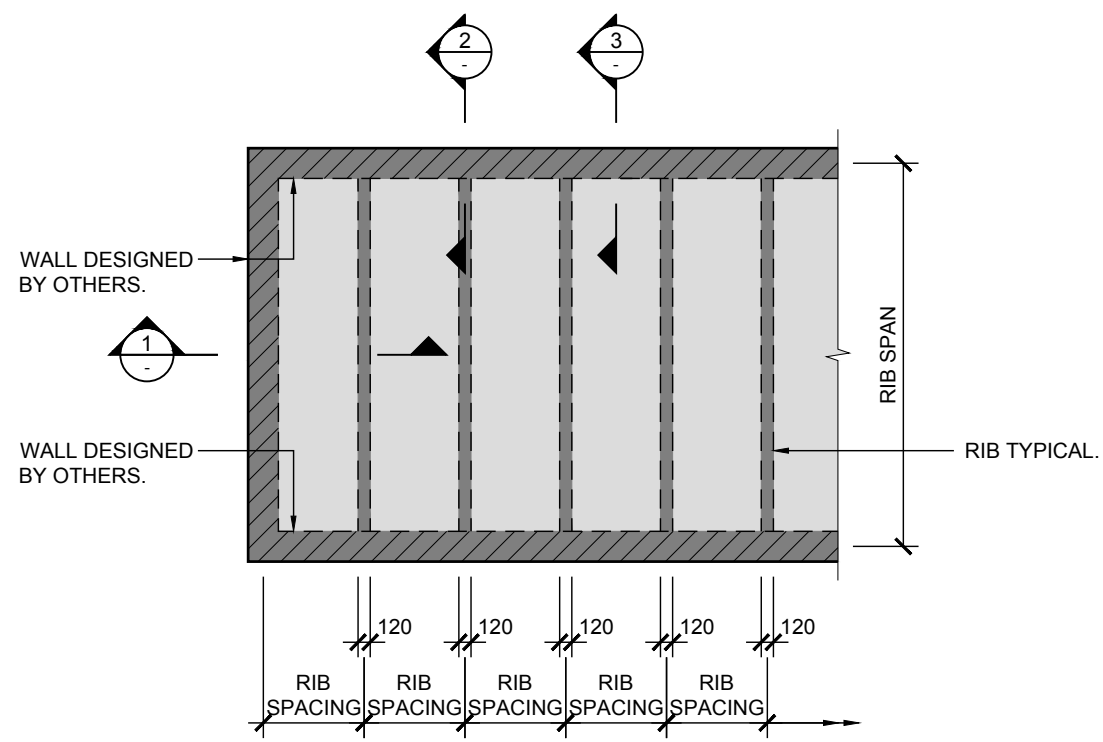
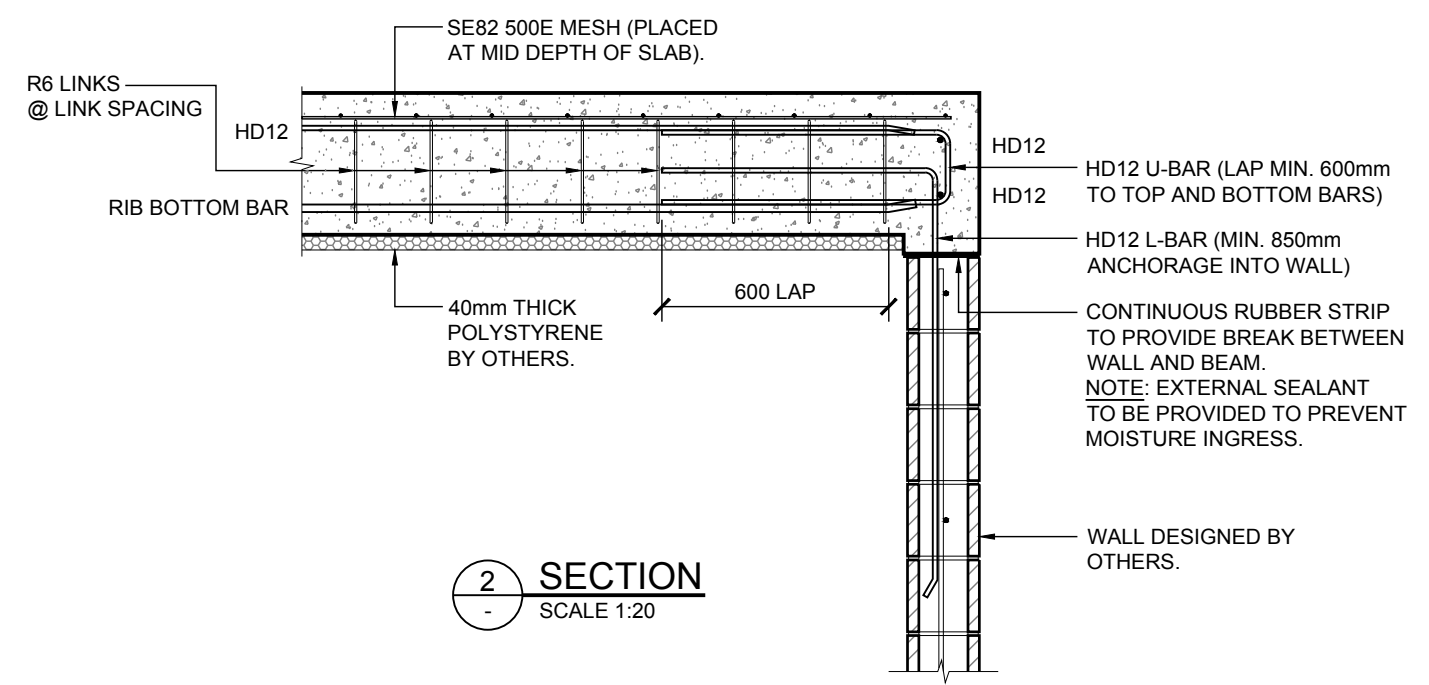
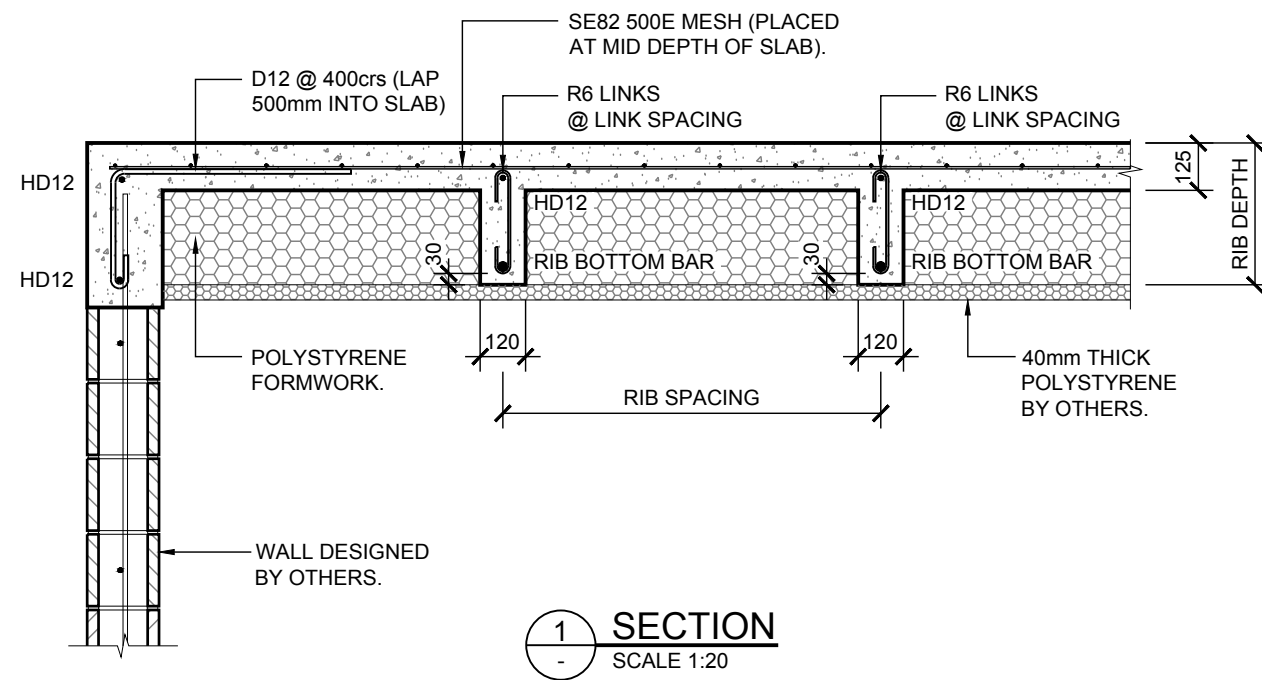

FLOOR LAYOUT
SCALE 1:75

CONSTRUCTION ISSUE

THIS DRAWING IS TO BE READ IN CONJUNCTION WITH ARCHITECT'S DRAWINGS

	CLIENT	PROJECT TITLE	DRAWING TITLE	REV.	BY.	DATE:	COMMENT:	DESIGN.	JOB No.	DRAWING No.	REV.
	MAXRAFT	MAXSPAN.	FLOOR LAYOUT AND CROSS SECTIONS.	0	V.M.	19-04-2018	ISSUED FOR CONSTRUCTION	P.A.	9092	S.03	0
								DRAWN.	SCALE @ A3		
								V.M.	1:20		

NOTES:

- DETAILS SHOWN ON THIS PAGE REFER TO THE MAXSPAN SUSPENDED FLOOR SYSTEM DESIGNED TO IMPOSED FLOOR ACTION OF A SELF-CONTAINED DWELLING (REFER TO TABLES 1 & 2) SUPPORTED ON A POLY BLOCK WALL (BY OTHERS).

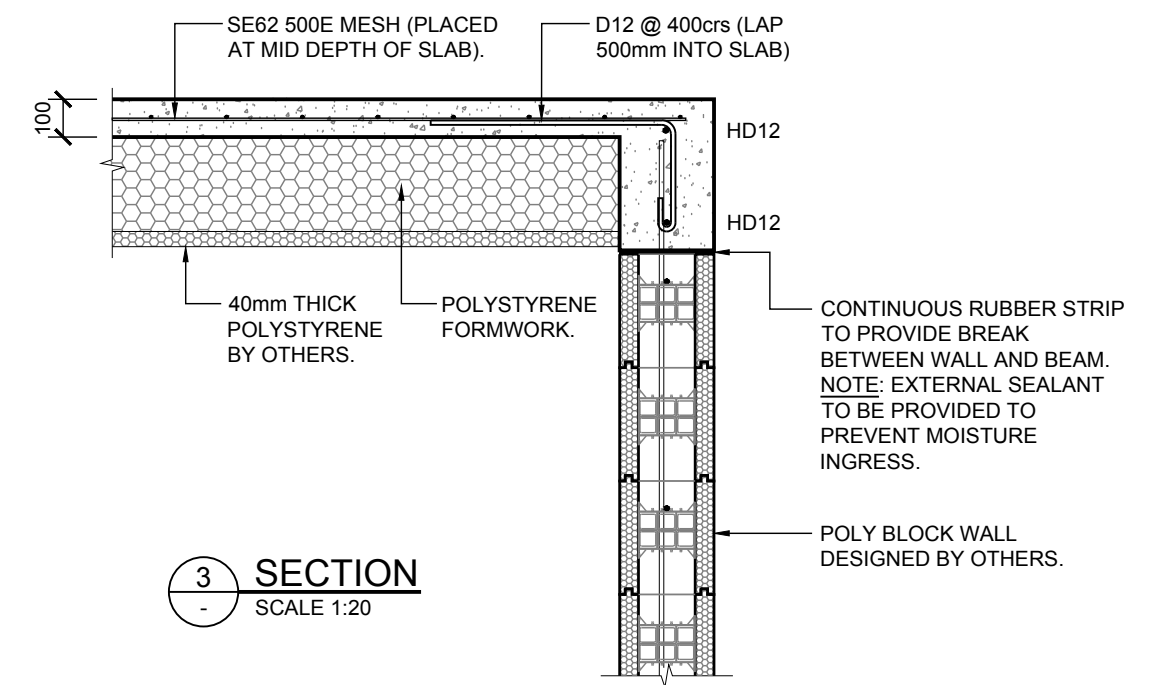
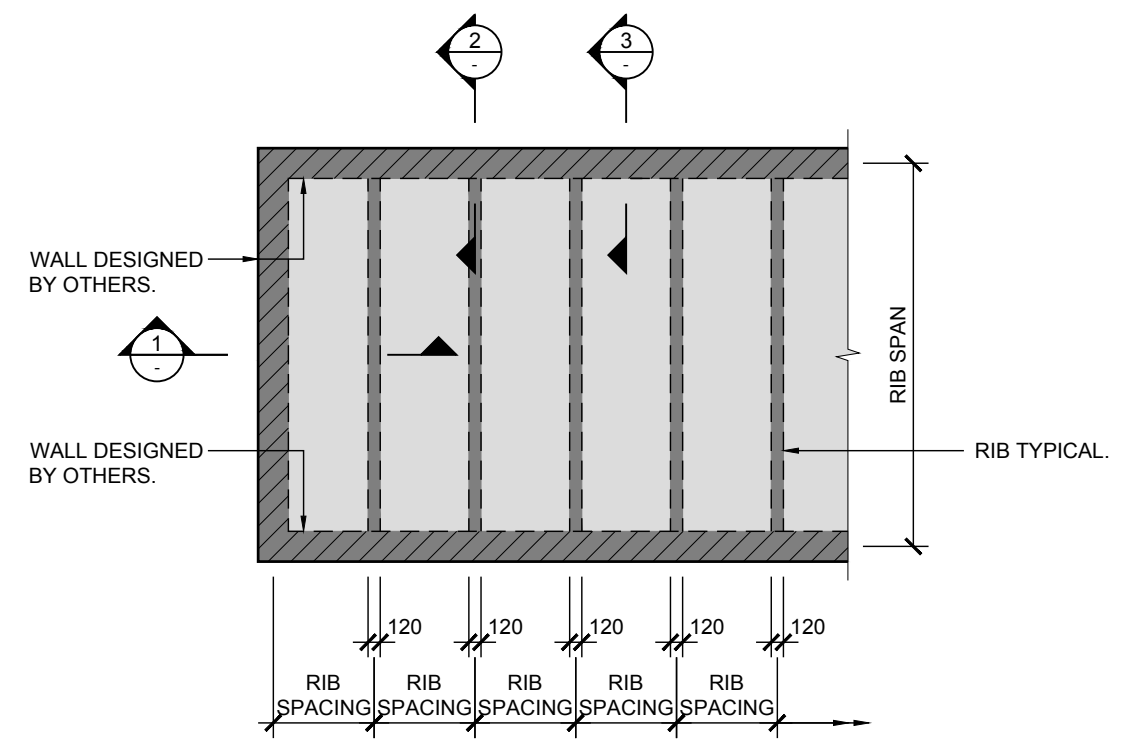
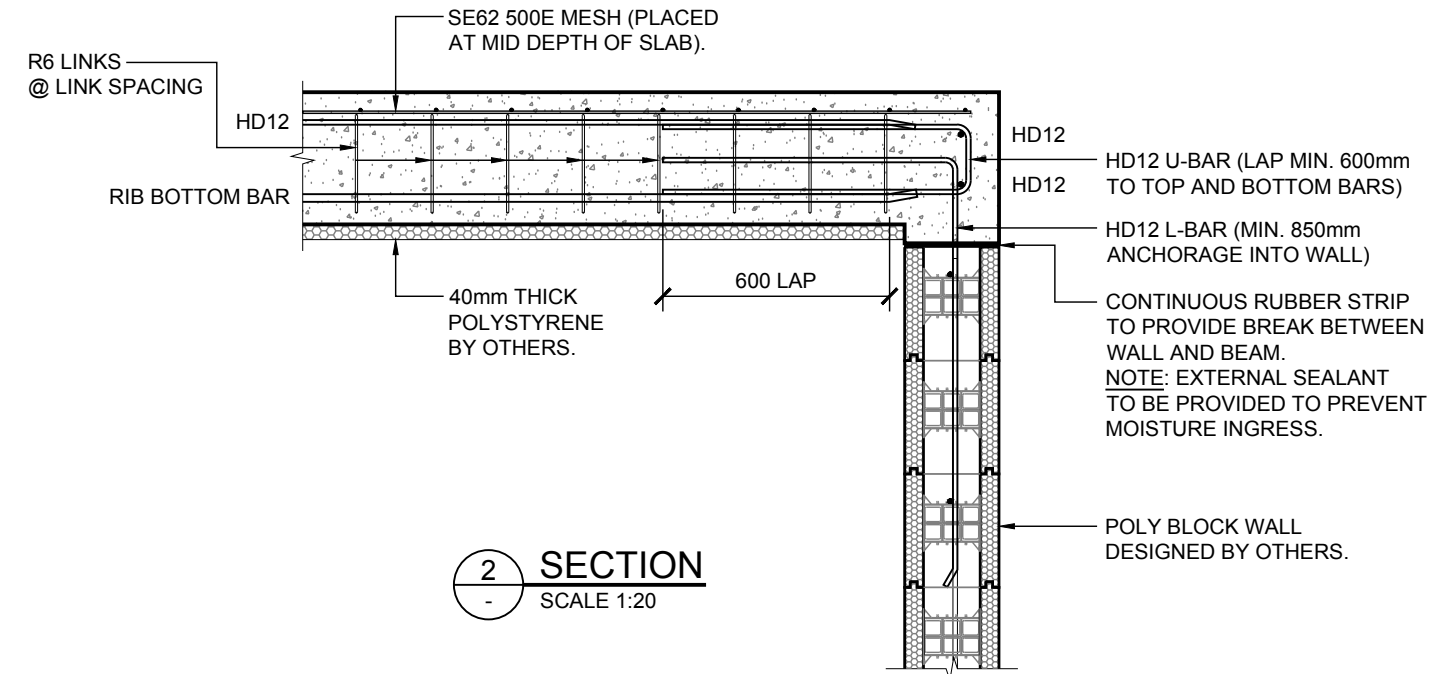
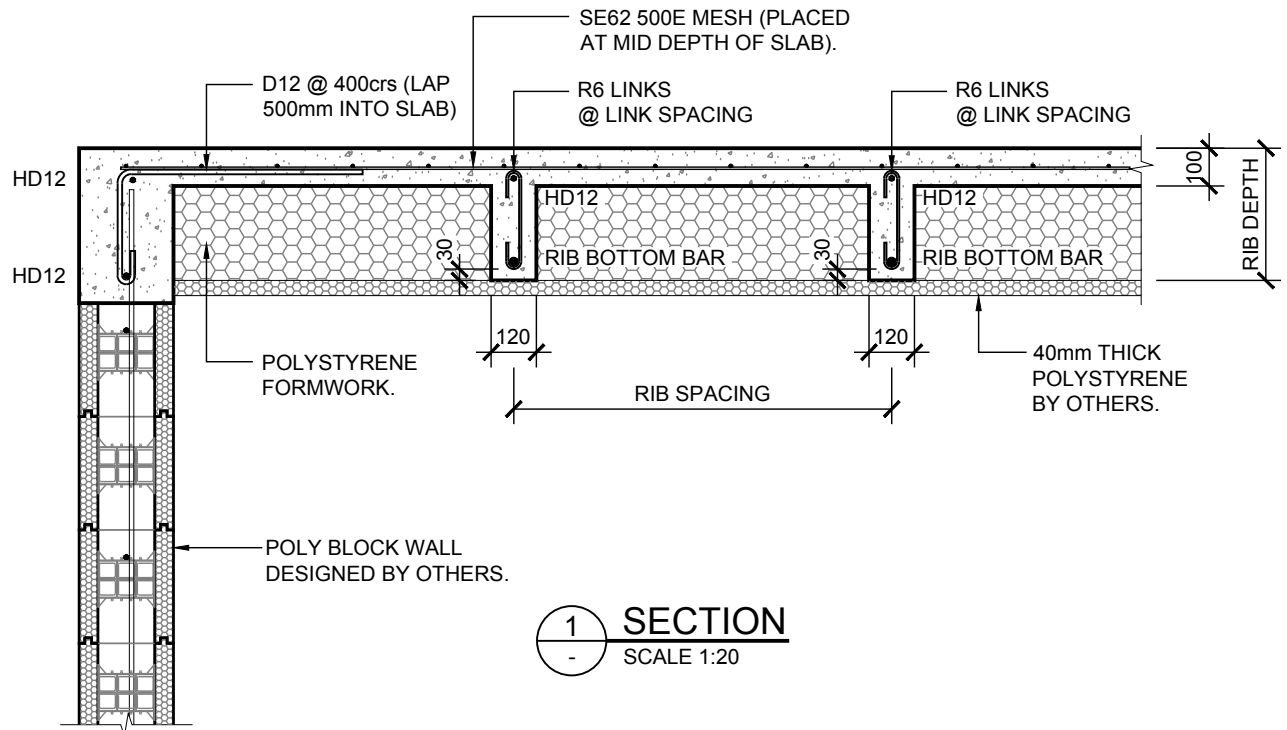

FLOOR LAYOUT
SCALE 1:75

CONSTRUCTION ISSUE

THIS DRAWING IS TO BE READ IN CONJUNCTION WITH ARCHITECT'S DRAWINGS

	CLIENT MAXRAFT	PROJECT TITLE MAXSPAN.	DRAWING TITLE FLOOR LAYOUT AND CROSS SECTIONS.	REV. 0	BY. V.M.	DATE: 19-04-2018	COMMENT: ISSUED FOR CONSTRUCTION	DESIGN. P.A.	JOB No. 9092	DRAWING No. S.04	REV. 0
								DRAWN. V.M.	SCALE @ A3 1:20		

NOTES:

- DETAILS SHOWN ON THIS PAGE REFER TO THE MAXSPAN SUSPENDED FLOOR SYSTEM DESIGNED TO IMPOSED FLOOR ACTION OF A LIGHT-VEHICLE TRAFFIC AREA (REFER TO **TABLE 3**) SUPPORTED ON A POLY BLOCK WALL (BY OTHERS).

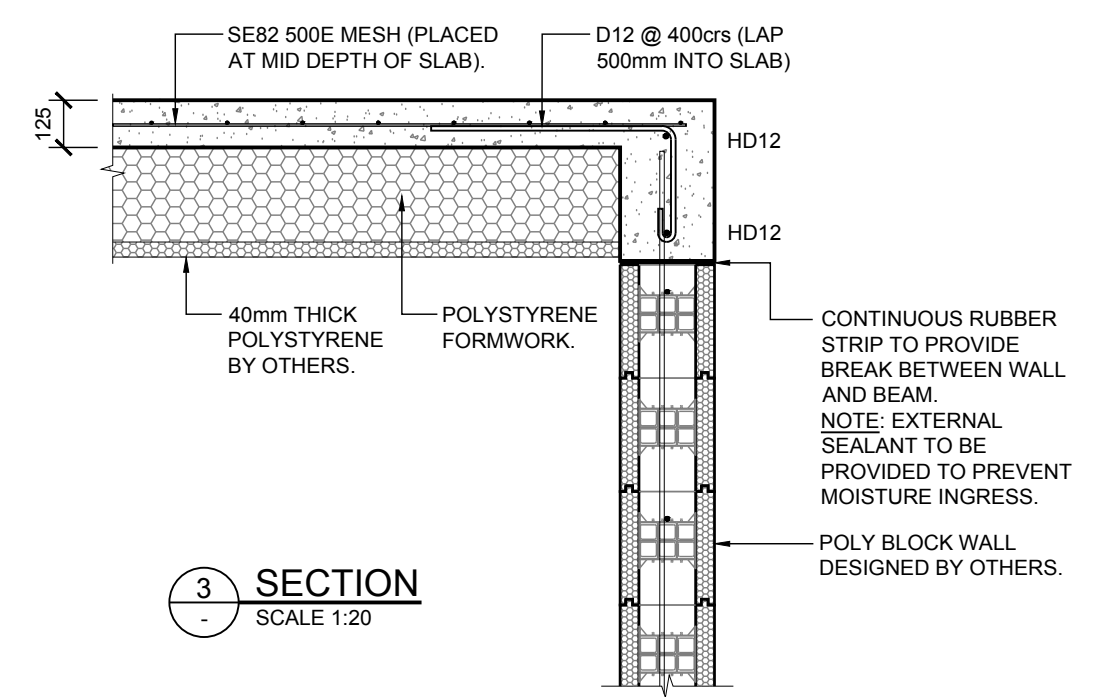
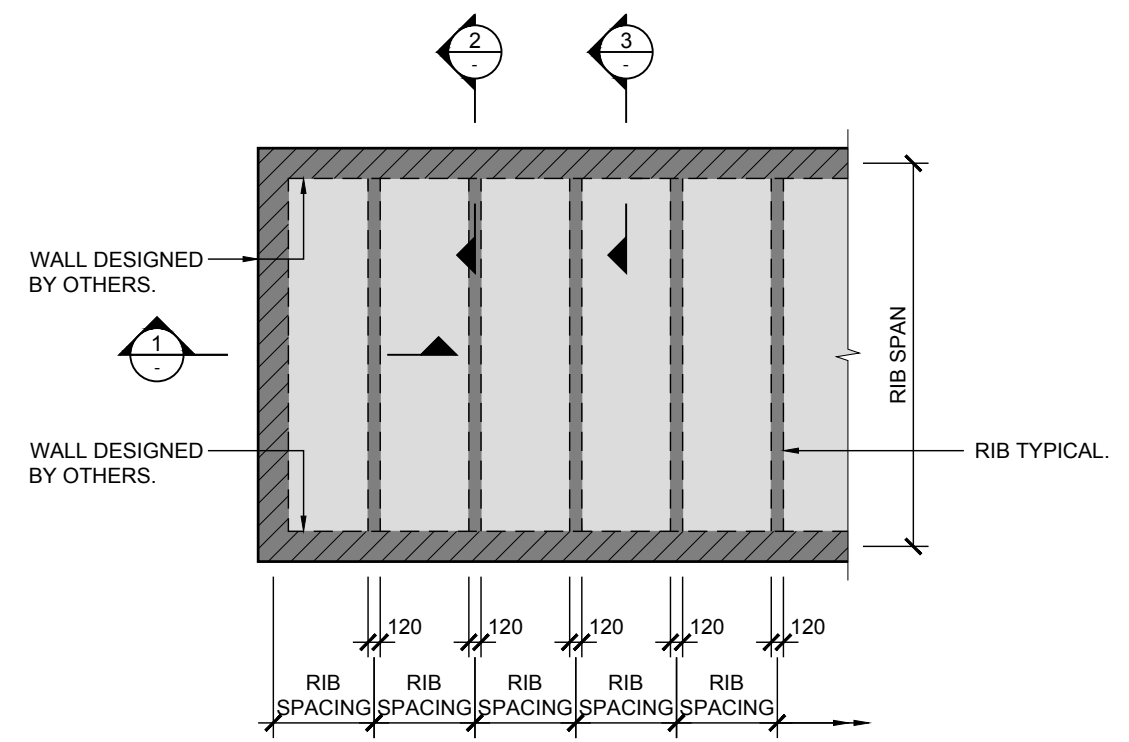
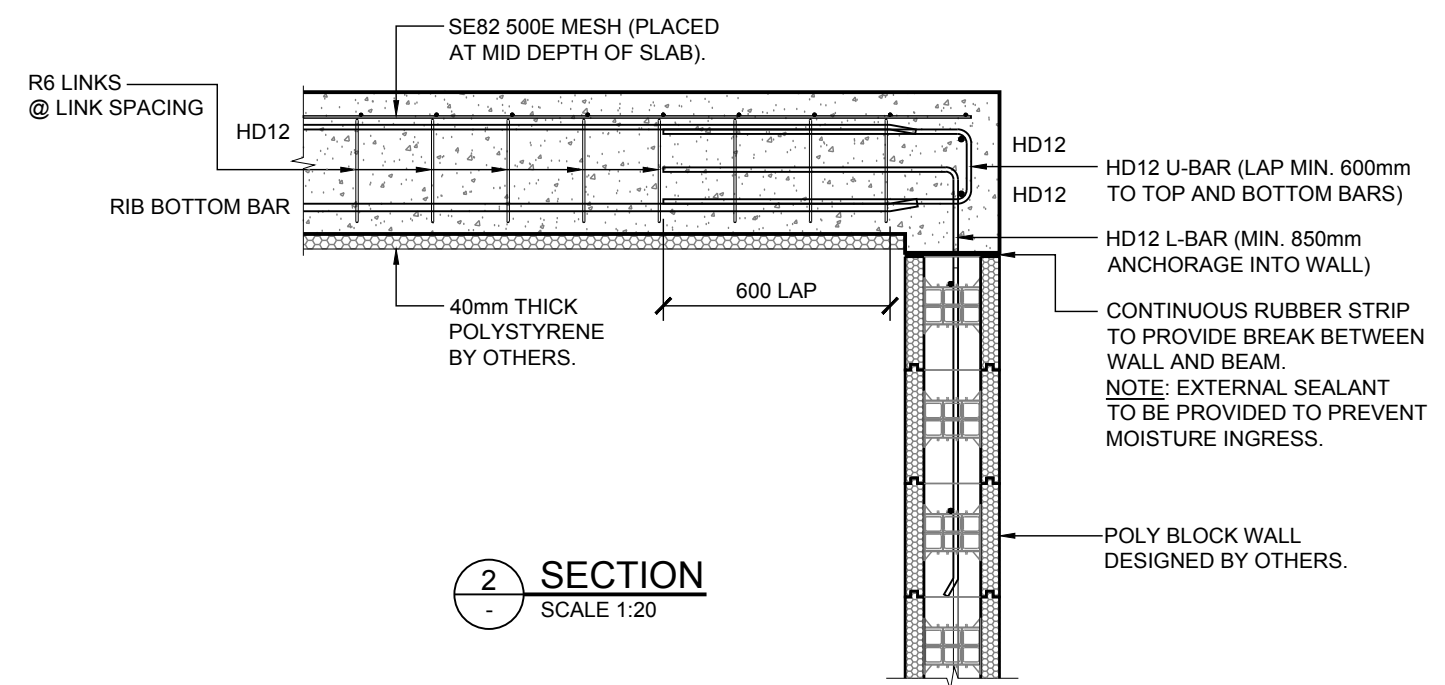
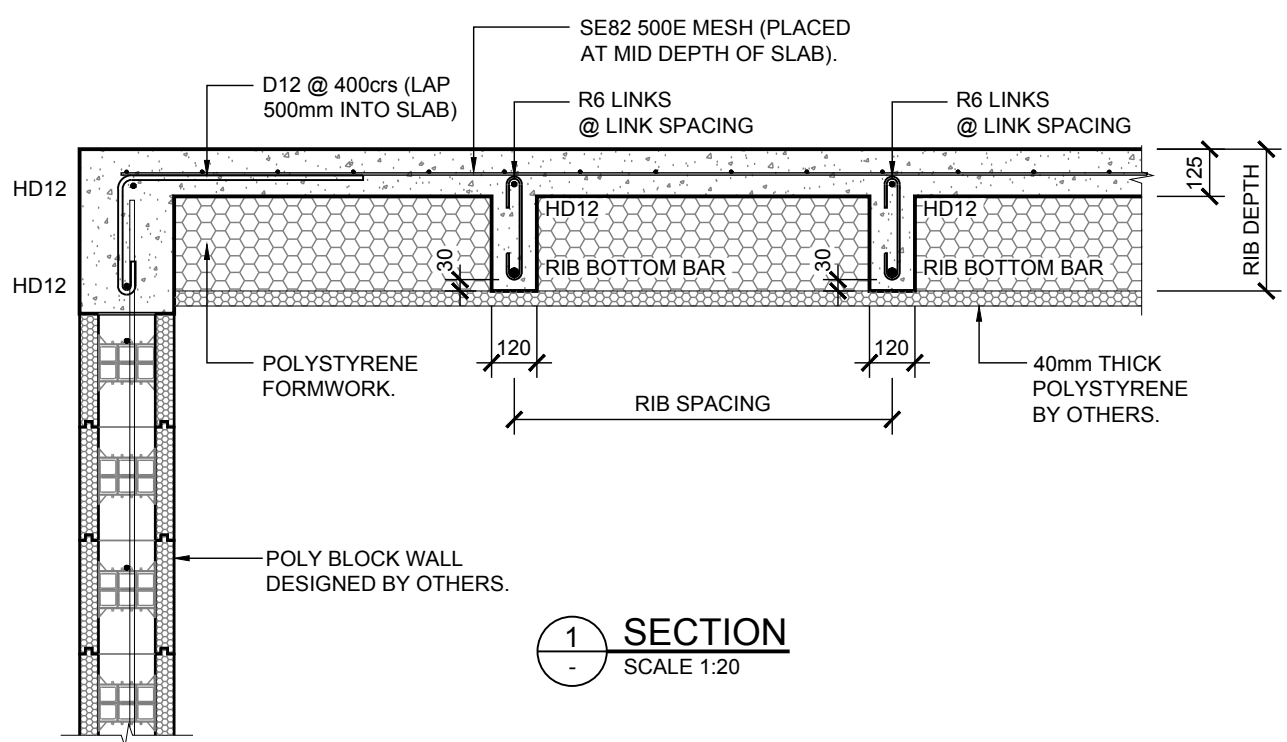

CONSTRUCTION ISSUE

THIS DRAWING IS TO BE READ IN CONJUNCTION WITH ARCHITECT'S DRAWINGS

	CLIENT MAXRAFT	PROJECT TITLE MAXSPAN.	DRAWING TITLE FLOOR LAYOUT AND CROSS SECTIONS.	REV. 0	BY. V.M.	DATE: 19-04-2018	COMMENT: ISSUED FOR CONSTRUCTION	DESIGN. P.A.	JOB No. 9092	DRAWING No. S.05	REV. 0
								DRAWN. V.M.	SCALE @ A3 1:20		